

Artwork Approval

Your Ref:
Our Ref:

Quantity:
Version: 1

Product Code: MG9605
Product Colour: WHITE

PRODUCT NOTES:

PLEASE BE AWARE, THE LOGO MAY NOT LINE UP WITH THE SIPPER.
THIS IS DUE TO US BEING UNABLE TO PRINT THE PRODUCT WITH THE LID ON.

We stock this item in the following colours



The dashed line is to demonstrate print area and will not appear on your printed item

PANTONE REFERENCE(S)

- Colour 1
- Colour 2

ARTWORK SCALE 50%

PRINTING CONCERNS:

PRINT LAYOUT

- LOGOS WILL BE DIRECTLY OPPOSITE
- LOGOS WILL NOT BE DIRECTLY OPPOSITE

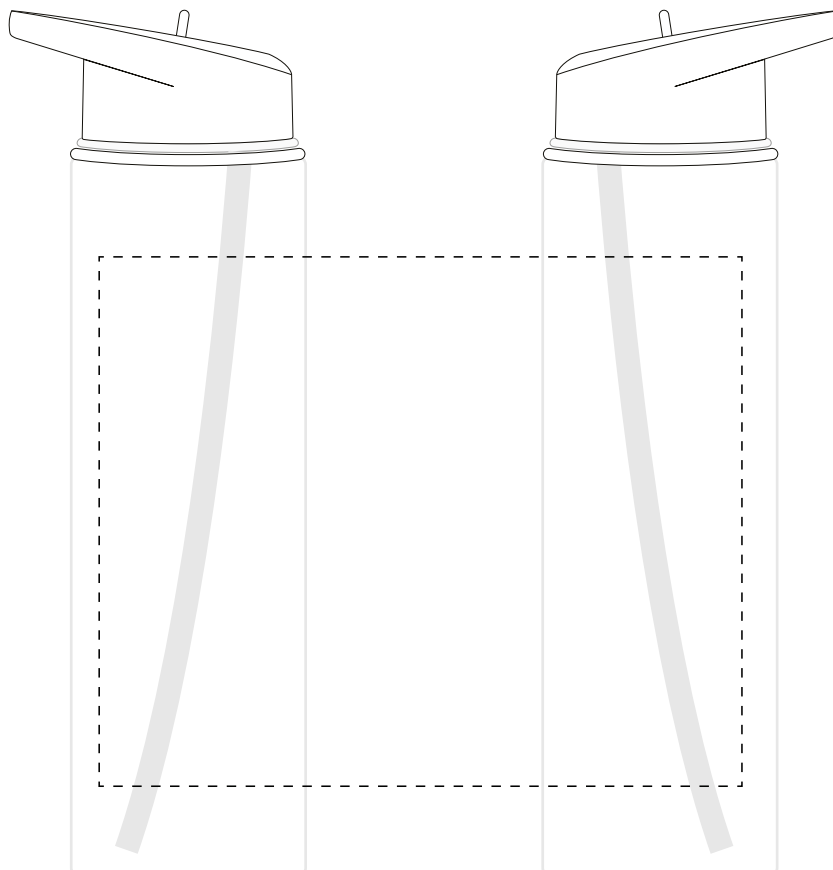

Please check the following are correct

QUANTITY CORRECT PRODUCT and PRODUCT COLOUR PRINT SIZE and POSITION PRINT COLOUR SPELLING, PHONE NUMBERS, EMAILS and WEBSITES

Any special print requirements must be advised at approval stage, however a new visual may have to be done and approved which may affect the lead time. We may at times advise you of our concerns with regard to the print or print colour on the pdf proof - if approval is given this is unfortunately at your own risk. If a photograph is required of the item this may be chargeable and this is quite often done on day of despatch and could delay your order if approval isn't received immediately.

We cannot accept liability for errors, however caused, which are evident in the proof and not indicated by you at this stage. You are liable for all relevant costs incurred in correcting such mistakes once the proof has been approved. Please note: Your order will not go into production until this proof is approved in writing. This product may have more than one print area, please check to ensure the print position is correct as mistakes cannot be rectified once the goods have been printed. Due to the restrictions and constraints of printing, we can only use 'coated' ink, therefore your pantone reference will need to be a 'C' code. Please double check the pantone colour against a coated pantone book before approving the artwork. The colour and texture of a product can also have an effect on the final print colour.

To proceed, please reply back to sender clearly stating that the proof is approved

ARTWORK SCALE 100%
Max print area: 170mm x 140mm

